



AIRBUS

Airbus A320 Family (V)

Airbus A318-100

Paper-based scale model design system Copyright © 2001-2025 — Airigami and Cascadia (Mauritius) Ltd. All rights reserved.
Aircraft manufacturer, airline, alliance, and incidental designs and logos are reproduced for the purpose of information, education, and commentary, which falls under the fair use doctrine of copyright law. All logos and designs remain the property of their respective copyright and trademark owners. No copyright infringement is intended.

Getting Started

The first step in building a paper model is, of course, the putting the design to paper. Some things to bear in mind:

- Airigami models are designed to fit A3 paper. Printing at 100% scale will produce models that are approximately 1:200 scale. However, you can use the scaling function in your printer settings to either increase or decrease the scale. For example, if you adjusted Adobe Acrobat print settings to print on A4 paper, you would print models at 1:400 scale.
- We strongly recommend that Airigami models be printed on heavier stock. We recommend glossy 80lbs paper — if the paper is too light (like normal office paper) the models will tend to 'sag'; if the paper is too heavy, it may be too difficult to fold or manipulate in the building process. (Glossy paper also makes the models look nicer.)

What You'll Need



Scissors | We recommend small or medium sized scissors that allow for careful cutting at sometimes tight angles.



Glue | We recommend solid 'stick' glue. Liquid style glue is not recommended as it may damage the paper on which the design is printed.



Tape | We recommend Scotch tape that is clear and durable. Regular tape can also be used, but be aware that it may discolor faster over time.



Exacto Knife | We recommend an Exacto knife for a limited number of cut-outs within shapes. A box cutter may also be used, but it is far more hazardous.

Phase 1 Empennage

Section T

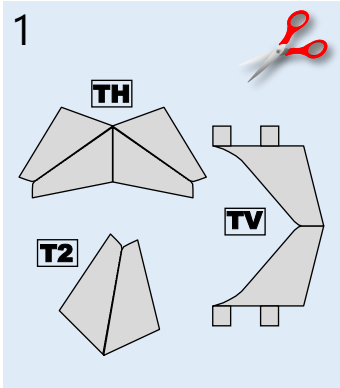

1 | Cut out these pieces:
TH Horizontal Stabilizer
T2 Vertical Stabilizer (Interior)
TV Vertical Stabilizer (Exterior)

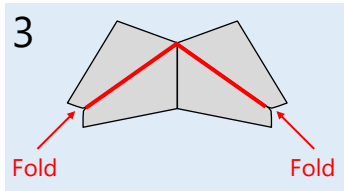
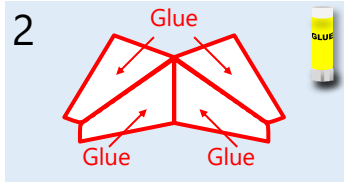

2 | Apply glue to the reverse side of **TH**.
 3 | Fold along the red lines indicated and adhere the reverse sides of **TH** together.

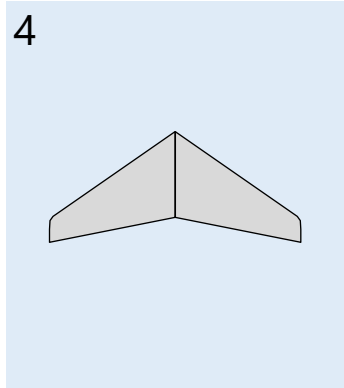

4 | Set aside **TH** until it is needed in Phase 3.

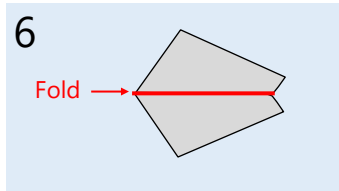
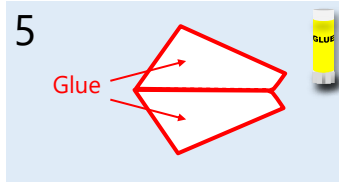

5 | Apply glue to the reverse side of **T2**.
 6 | Fold along the red line indicated and adhere the reverse sides of **T2** together.

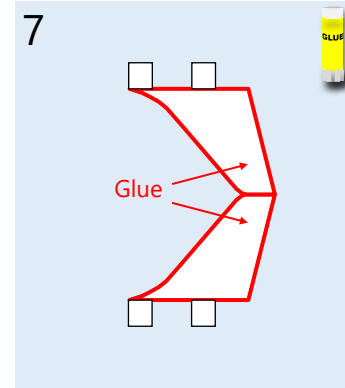

7 | Apply glue to the reverse side of **TV**.

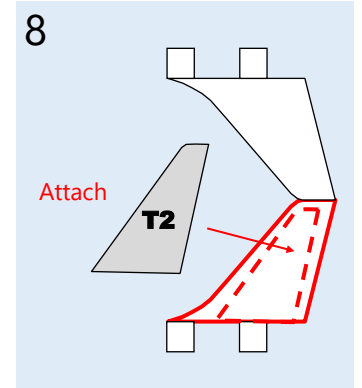

8 | Attach **T2** to the reverse of one side of **TV**.

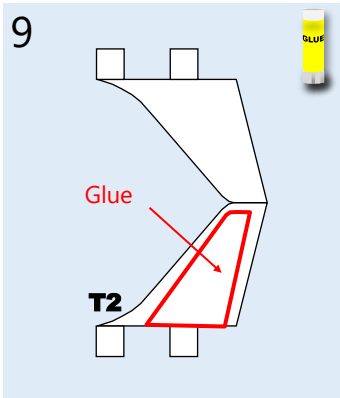

9 | Apply glue to the visible side of **T2**.

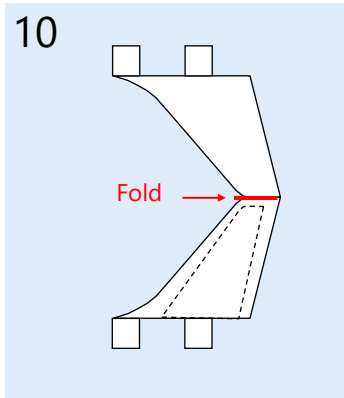

10 | Fold along the red line indicated and adhere the reverse sides of **TV** together.

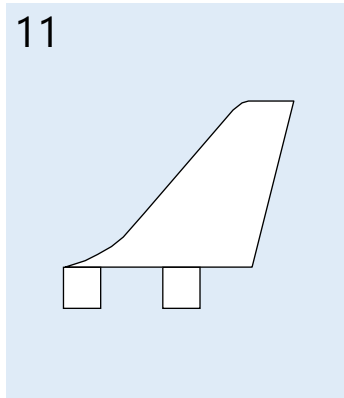

11 | Set aside **TV** until it is needed in Phase 3.

Phase 2 Ballast

Section B

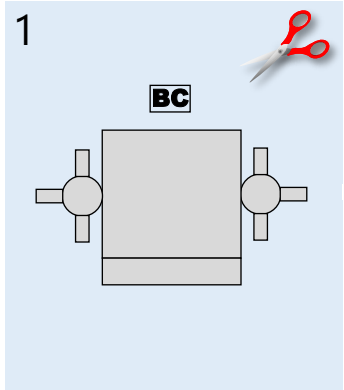

1 | Cut out these pieces:
BC Ballast Container

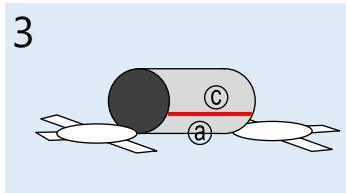
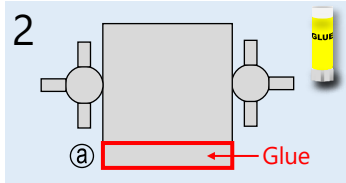

2 | Apply glue to the printed side of **BC** (area **a** only).
 3 | Curve or roll **BC** (do not fold). Adhere tab **a** to edge **c**.

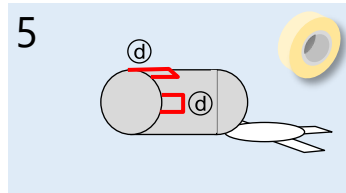
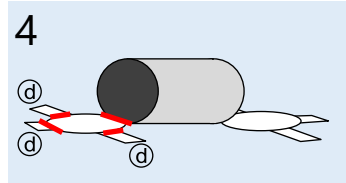

4 | Fold along the red lines indicated.
 5 | Apply tape over **d** tabs to adhere to cylinder.

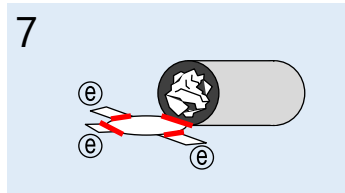
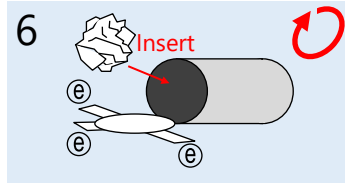

6 | Insert scrap paper (scrunched up) into the open cylinder. Insert as much as will comfortably fit.
 7 | Fold along the red lines indicated.

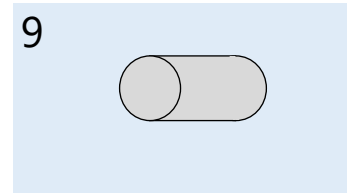
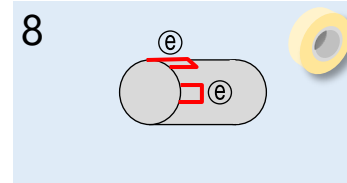

8 | Apply tape over **e** tabs to adhere to cylinder.
 9 | Set aside **BC** until it is needed in Phase 3.

Phase 3 Fuselage

Section F

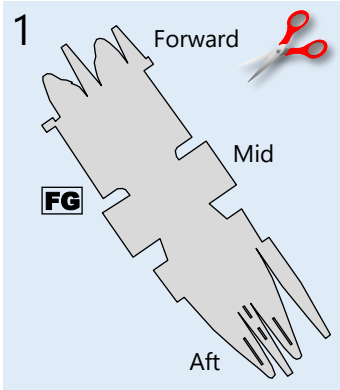

1 | Cut out these pieces:
FG Fuselage

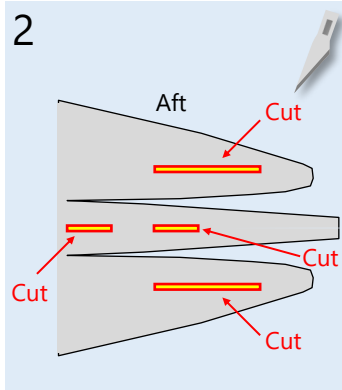

2 | Cut out the yellow* sections at the **Aft** end of **FG**.
* If the predominant color scheme is yellow, the sections to cut out will be green.

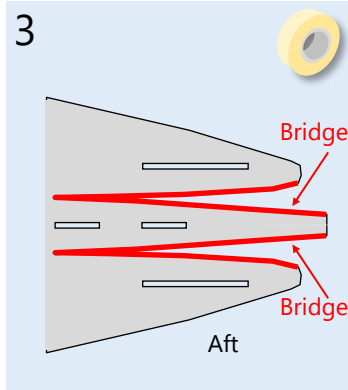

3 | At the **Aft** end of **FG** pull the sides of the fuselage to the center. Apply tape to bridge the edges as indicated.

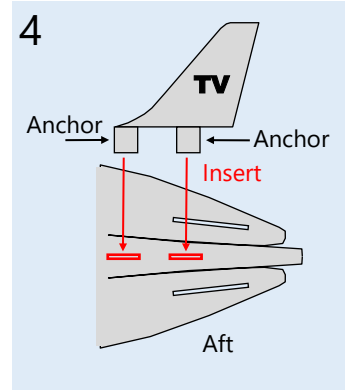

4 | Insert the **Anchors** of **TV** into the slots indicated.

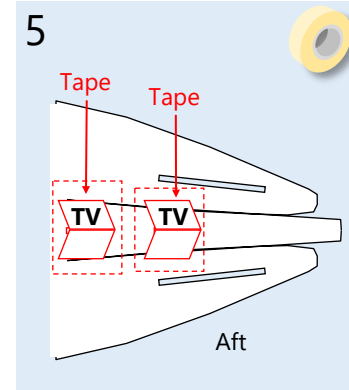

5 | Pull the **Anchors** of **TV** outward to be flush against reverse side of **FG**. Apply tape over the **Anchors** and secure them to **FG**.

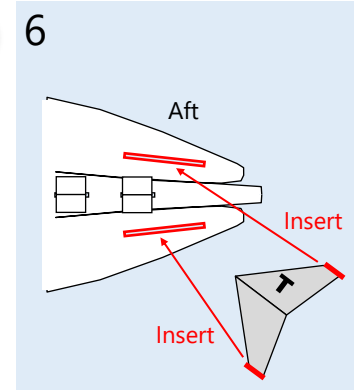

6 | Pull each corner of **TH** through each of the two **FG** slots as indicated. Ensure that **TH** is centered equally between the two slots.

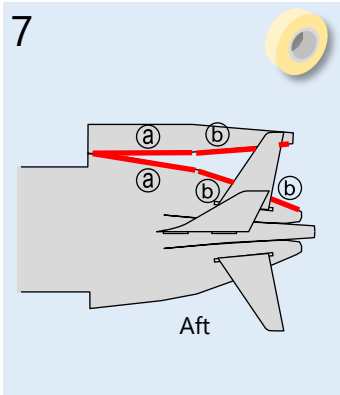

7 | Curve or roll **FG** (do not fold the top of **FG**).
Apply tape (or glue) to adhere the following **FG** edges together as indicated: **a > a** | **b > b**.

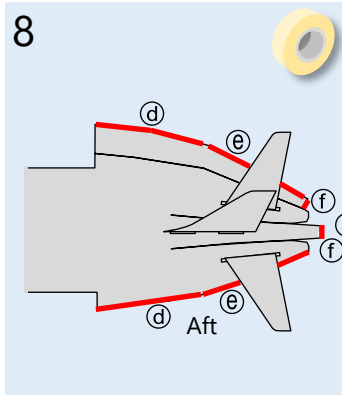

8 | Apply tape (or glue) to adhere the following **FG** edges together as indicated: **d > d** | **e > e** | **f > f** | **g > g**.

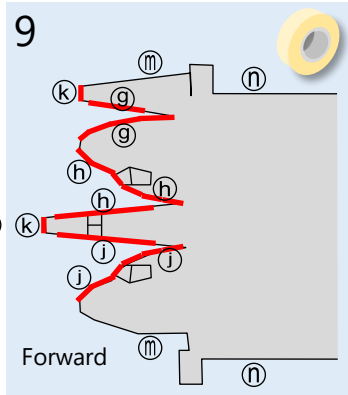

9 | Curve or roll **FG** (do not fold the top of **FG**).
Apply tape (or glue) to adhere the following **FG** edges together as indicated: **g > g** | **h > h** | **j > j** | **k > k**.

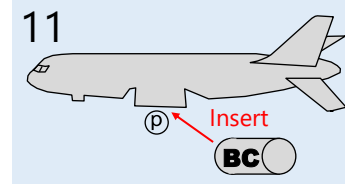
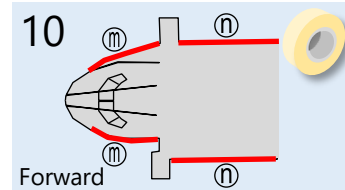

10 | Apply tape (or glue) to adhere the **FG** edges together as indicated: **m > m** | **n > n**.
11 | Insert **BC** into **FG** between the **p** tabs. Push **BC** as far forward within **FG** as possible.

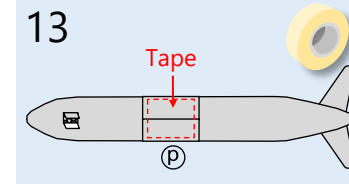
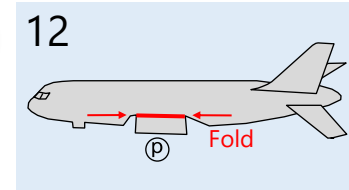

12 | Fold along the red line indicated on both sides of **FG**.
13 | Apply tape (or glue) to adhere the following **FG** tabs as indicated: **p > p**.

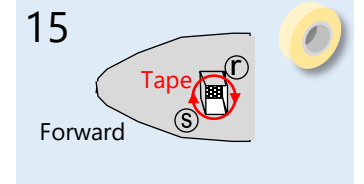
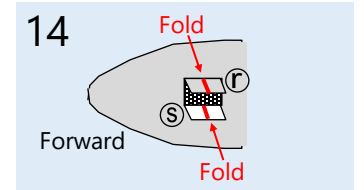

14 | Fold along the red line on the following **FG** tabs as indicated: **r**, **s**.
15 | Apply tape (or glue) to adhere the following **FG** tabs as indicated: **r > r**, **s > s**.

Phase 4 Engines

Section E

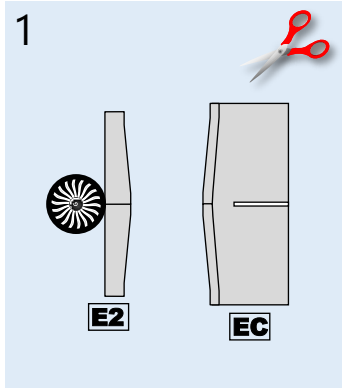

1 | Cut out these pieces:
EC Engine Cowling
E2 Engine Interior

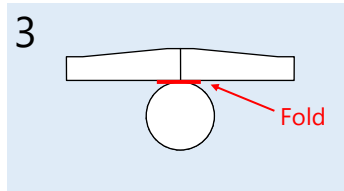
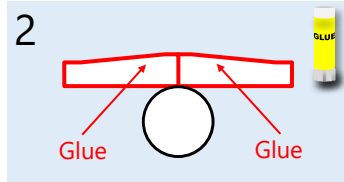

2 | Apply glue to the reverse side of **E2** as indicated.
 3 | Fold along the red line indicated.

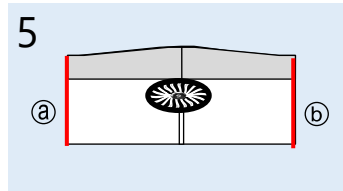
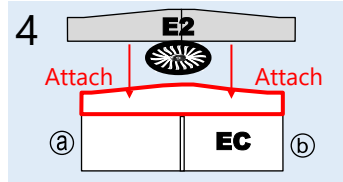

4 | Attach **E2** to the reverse side of **EC**.
 5 | Curve or roll **EC** (do not fold). Attach edges **a** > **b**.

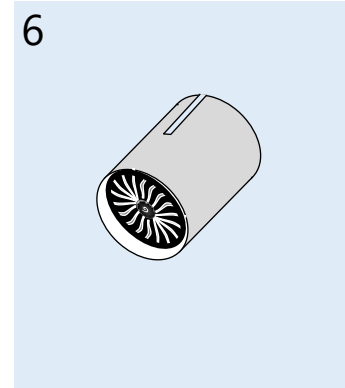

6 | Set aside **EC** until it is needed in Phase 6.

Phase 5 Landing Gear

Section G

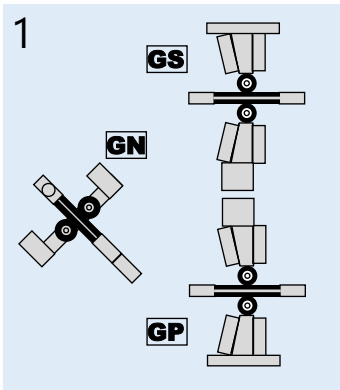

1 | Cut out these pieces:
GN Nose Gear
GP Main Gear Port
GS Main Gear Starboard

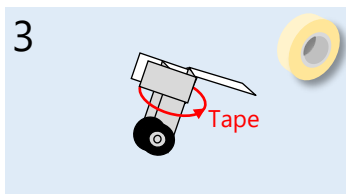
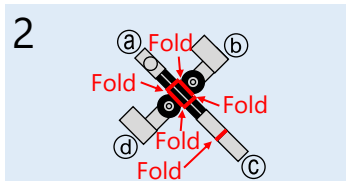

2 | Fold along the red lines indicated.
 3 | Apply tape (or glue) to adhere the following **GN** tabs as indicated: **a > b > c > d**.

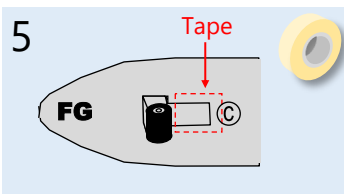
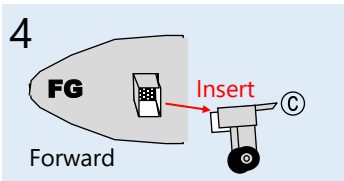

4 | Insert **r/s** tab of **FG** into **GN**. Push **FG** as far into **GN** as possible.
 5 | Apply tape (or glue) to adhere **c** tab of **GN** to the underside of **FG**.

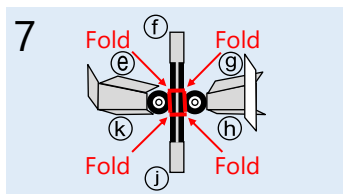
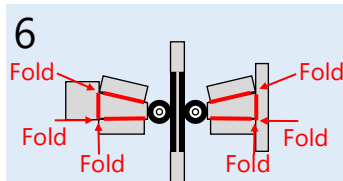

6 | Fold along the red lines indicated for **GP** and **GS**.
 7 | Fold along the red lines indicated for **GP** and **GS**.

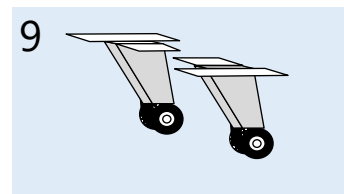
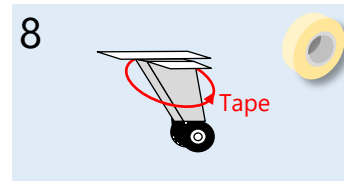

8 | Apply tape (or glue) to adhere the following **GP** tabs as indicated: **e > f > g | h > j > k**. Repeat for **GS**.
 9 | Set aside **GP** and **GS** until it is needed in Phase 6.

Phase 6 Wings

Section W

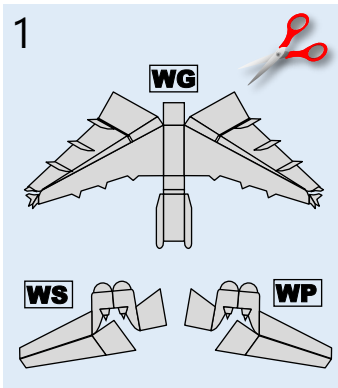

1 | Cut out these pieces:
WG Wing (Exterior)
WP Wing (Interior) Port
WS Wing (Interior) Starboard

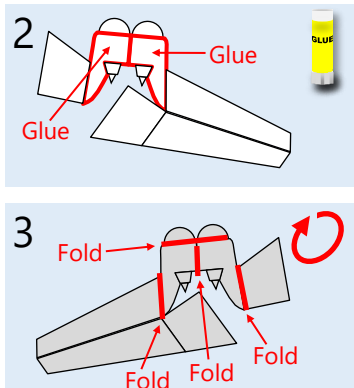

2 | Apply glue to the reverse side of **WP** and **WS** as indicated.
 3 | Fold along the red lines indicated.

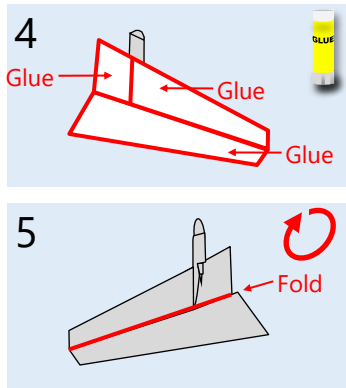

4 | Apply glue to the reverse side of **WP** and **WS** as indicated.
 5 | Fold along the red line indicated. Adhere the two sides together.

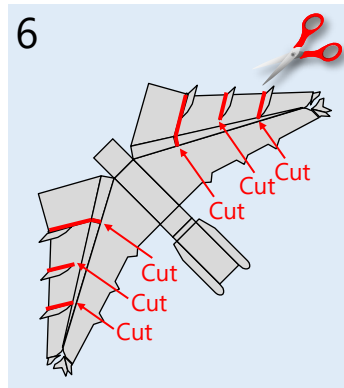

6 | Cut along the red lines as indicated.

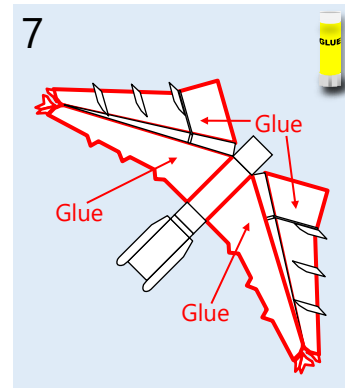

7 | Apply glue to the reverse side of **WG** as indicated.

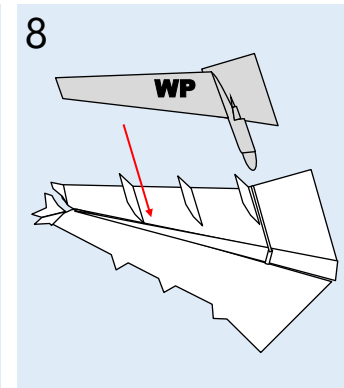

8 | Attach **WP** to the reverse of one side of **WG** and attach **WS** to the other reverse side.

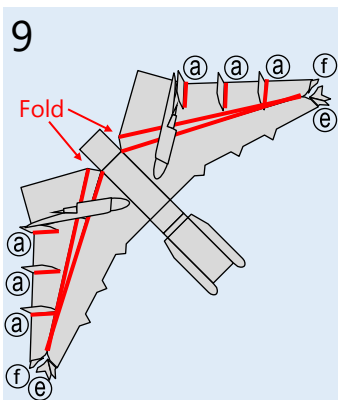

9 | Fold along the red lines indicated. Adhere the two sides of the wing together. Fold out the **a** wing fairings indicated.

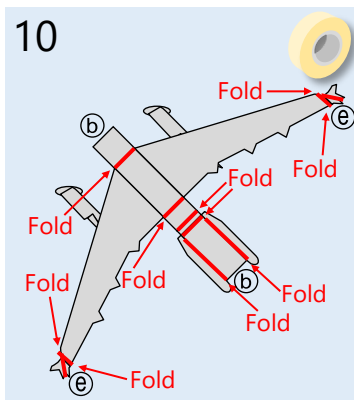

10 | Fold along the red lines indicated. Apply tape to adhere the following **WG** tabs as indicated: **b** > **b**. Fold the **e** wing fences along the red lines as indicated. Adhere **e** > **f**.

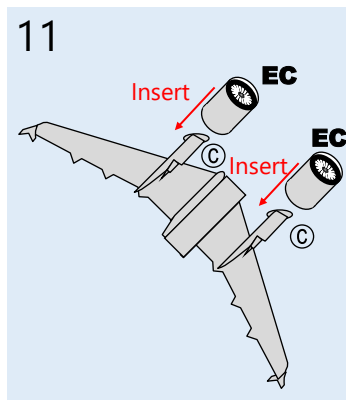

11 | Insert each **EC** onto the **WP** and **WS** c pilons.

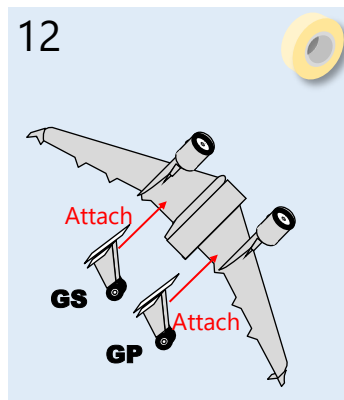

12 | Apply tape (or glue) to adhere **GS** to the starboard underside of **WG** and **GP** to the port underside of **WG**.

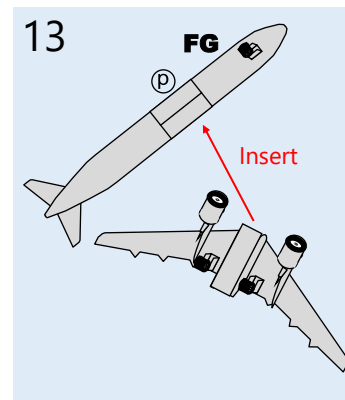

13 | Insert **WG** into **p** recess of **FG**. Tape (or glue) may be applied to permanently adhere. Or, if not adhered, the sections can be separated for easy storage.

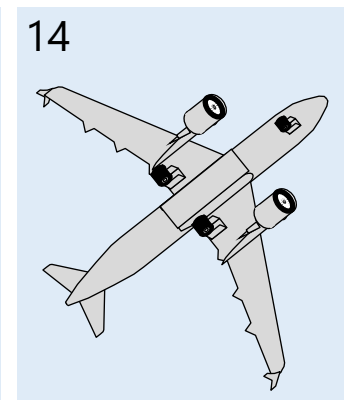

14 | Final assembly of the wings.