



## TEMPLATE

**8GBAW20H26**

***BOEING 747-400***

Parts included in this package:

FF	Fuselage Forward	Page 2	TH	Horizontal Stabilizer	Page 5
NG	Nose Landing Gear	Page 2	WS	Wing, Starboard	Page 6
FA	Fuselage Aft	Page 3	GS	Main Landing Gear Strut	Page 6
TV	Vertical Stabilizer	Page 4	WP	Wing, Port	Page 7
WB	Wing Box	Page 4			
MG	Main Landing Gear	Page 4			
CG	Center Landing Gear	Page 4			
WS	Wing Struts	Page 4			
EC	Engine Cowlings	Page 5			
EI	Engine Interiors	Page 5			

For best results, we recommend that this package be printed on the following paper stocks:  
 Pages 2-7 Model Glossy 80lbs

This is a genuine, official Airigami design. This design is provided free-of-charge - you should never, ever pay for this design. However, we strongly urge you to consider donating to Airigami at [www.papieravion.org](http://www.papieravion.org). Airigami was established so that the joy of airline modeling can be available to everybody. Please consider making a donation of \$5, \$20, \$50 or whatever you can to help keep Airigami alive and, best of all, free.

**INSTRUCTIONS**

For instructions on how to build this model, refer to manual **INSTRUCTIONS D**



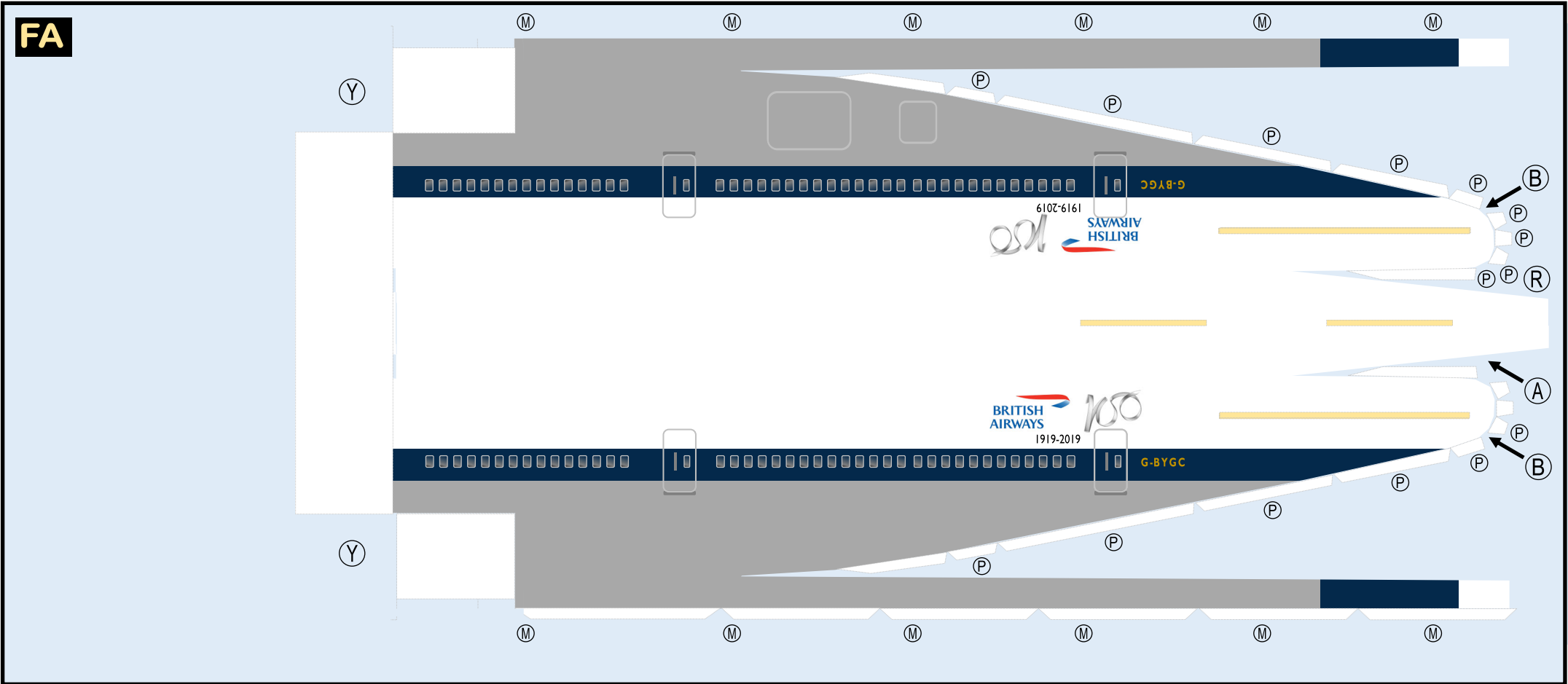

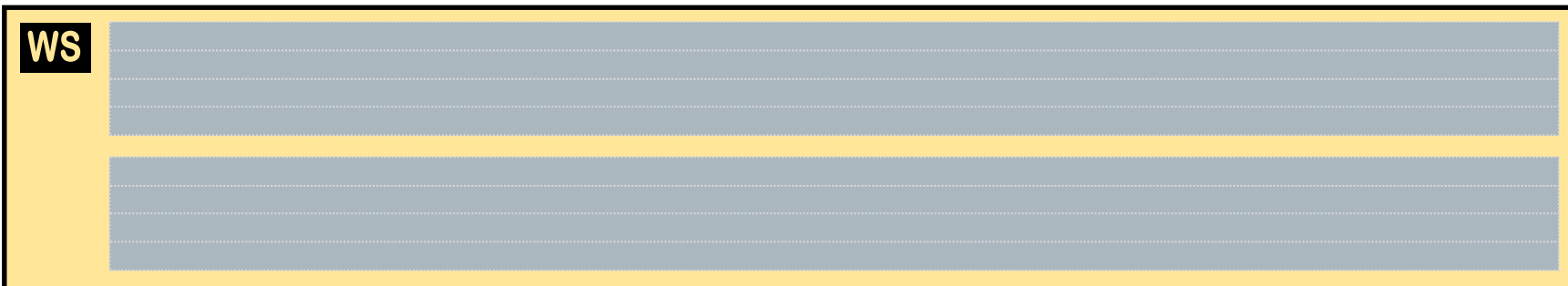
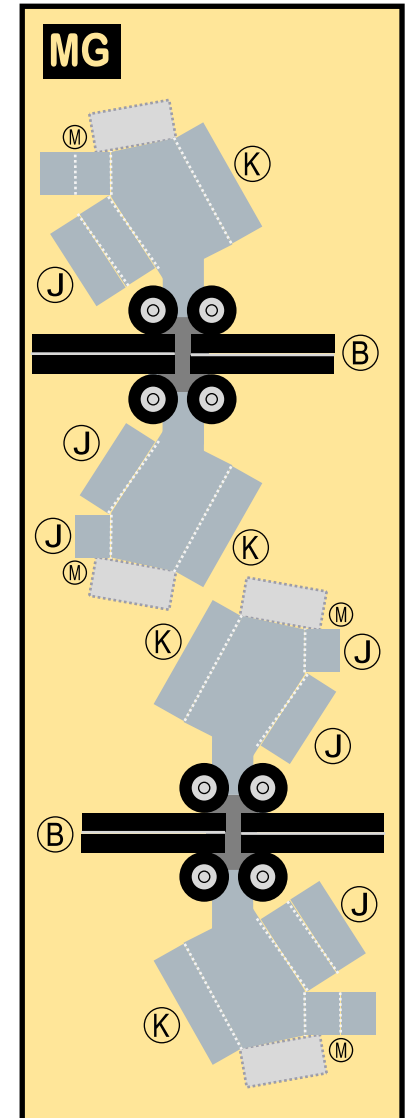
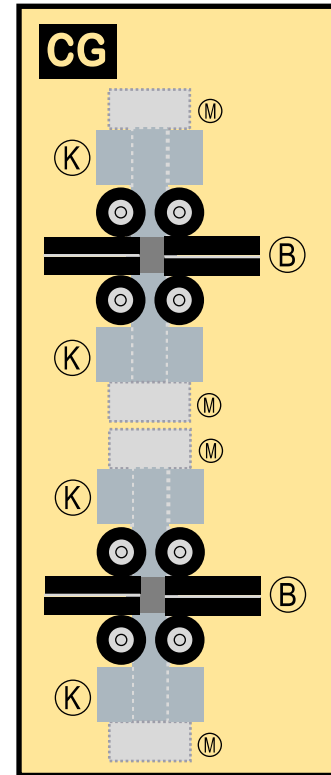
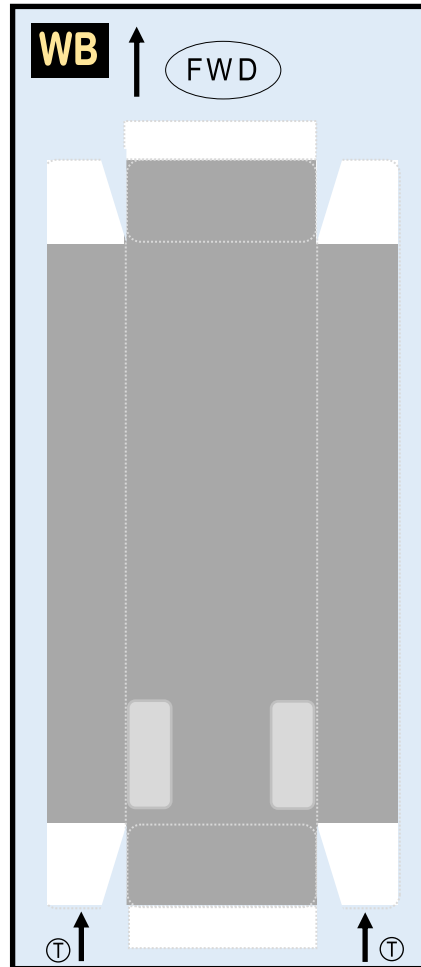
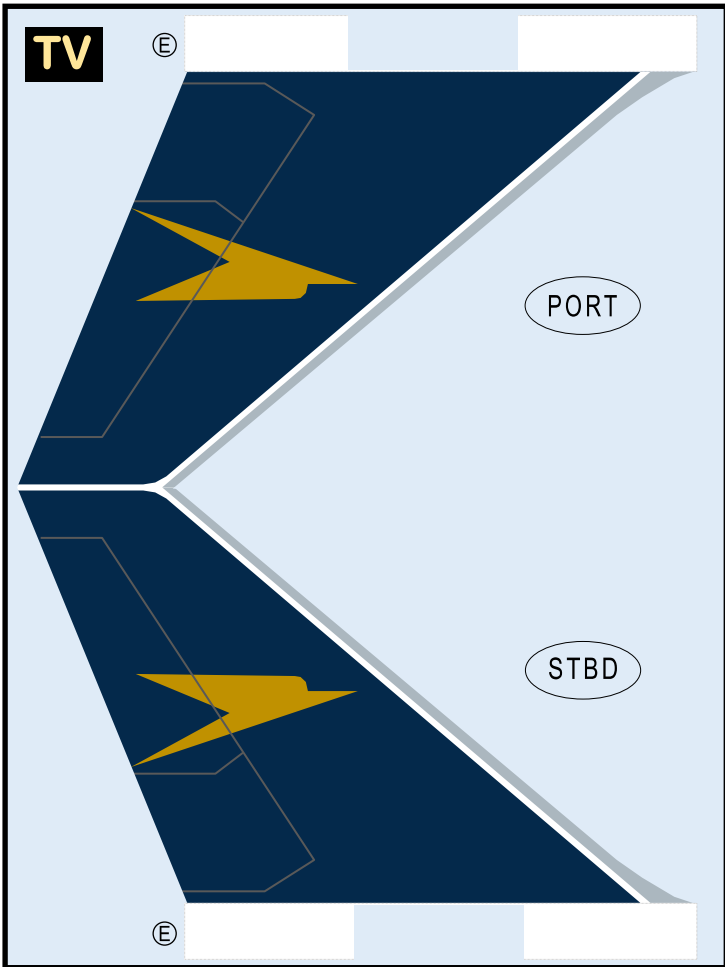

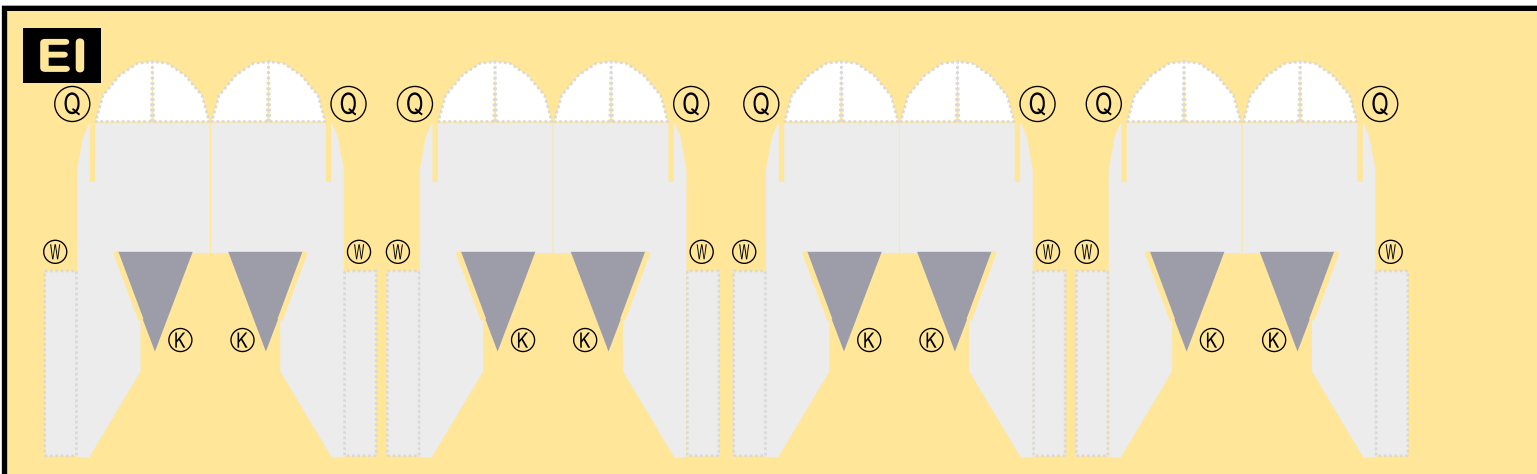
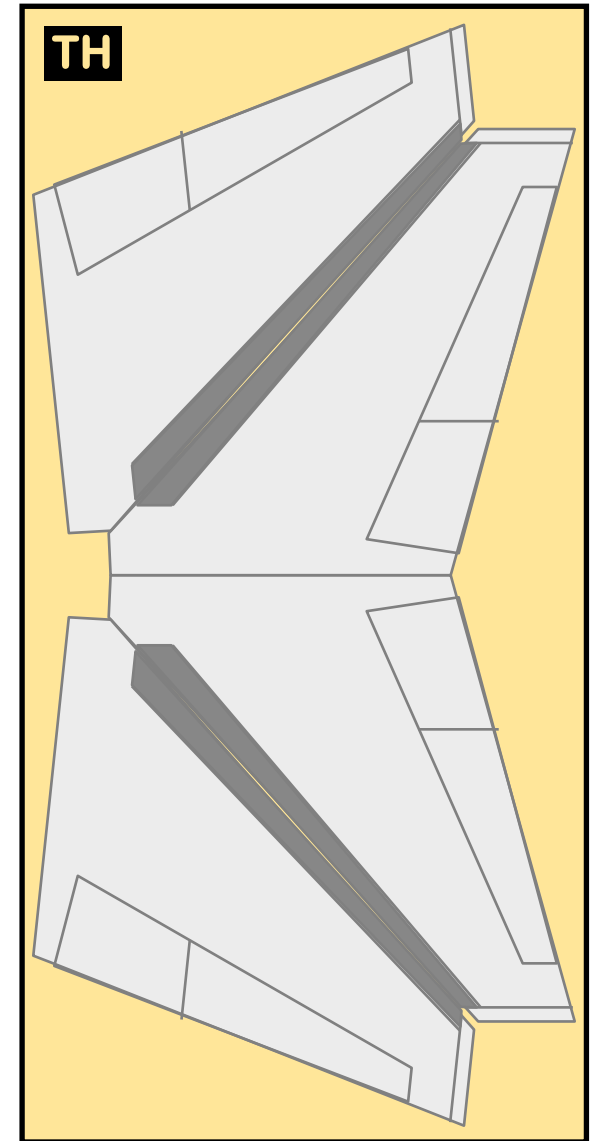
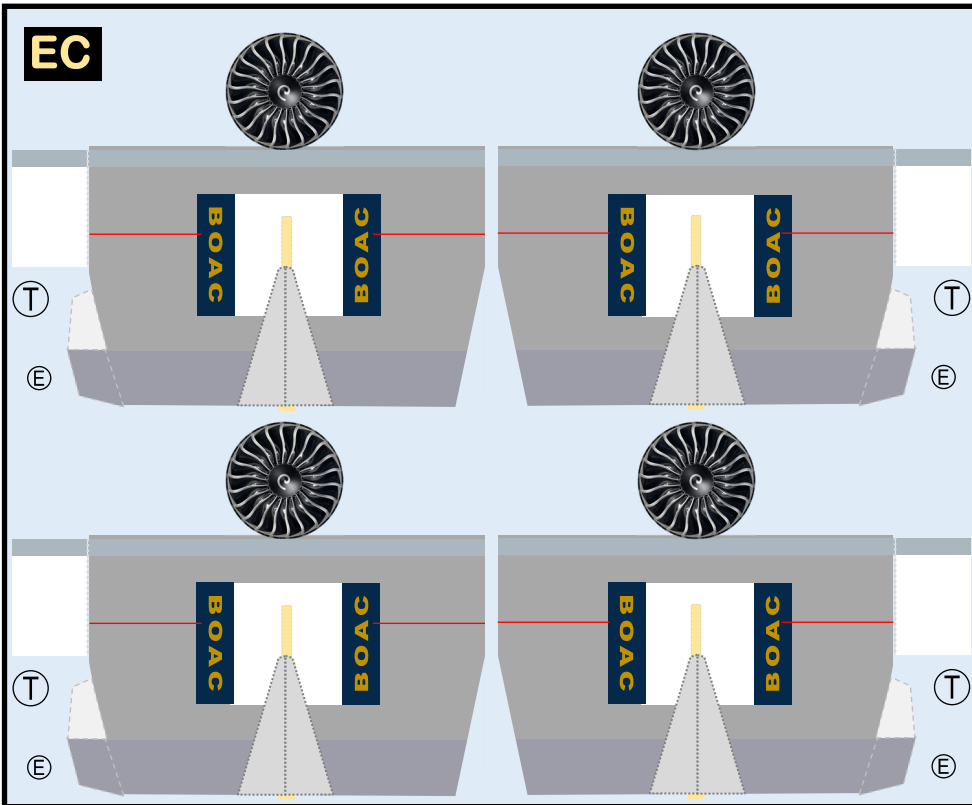

WS

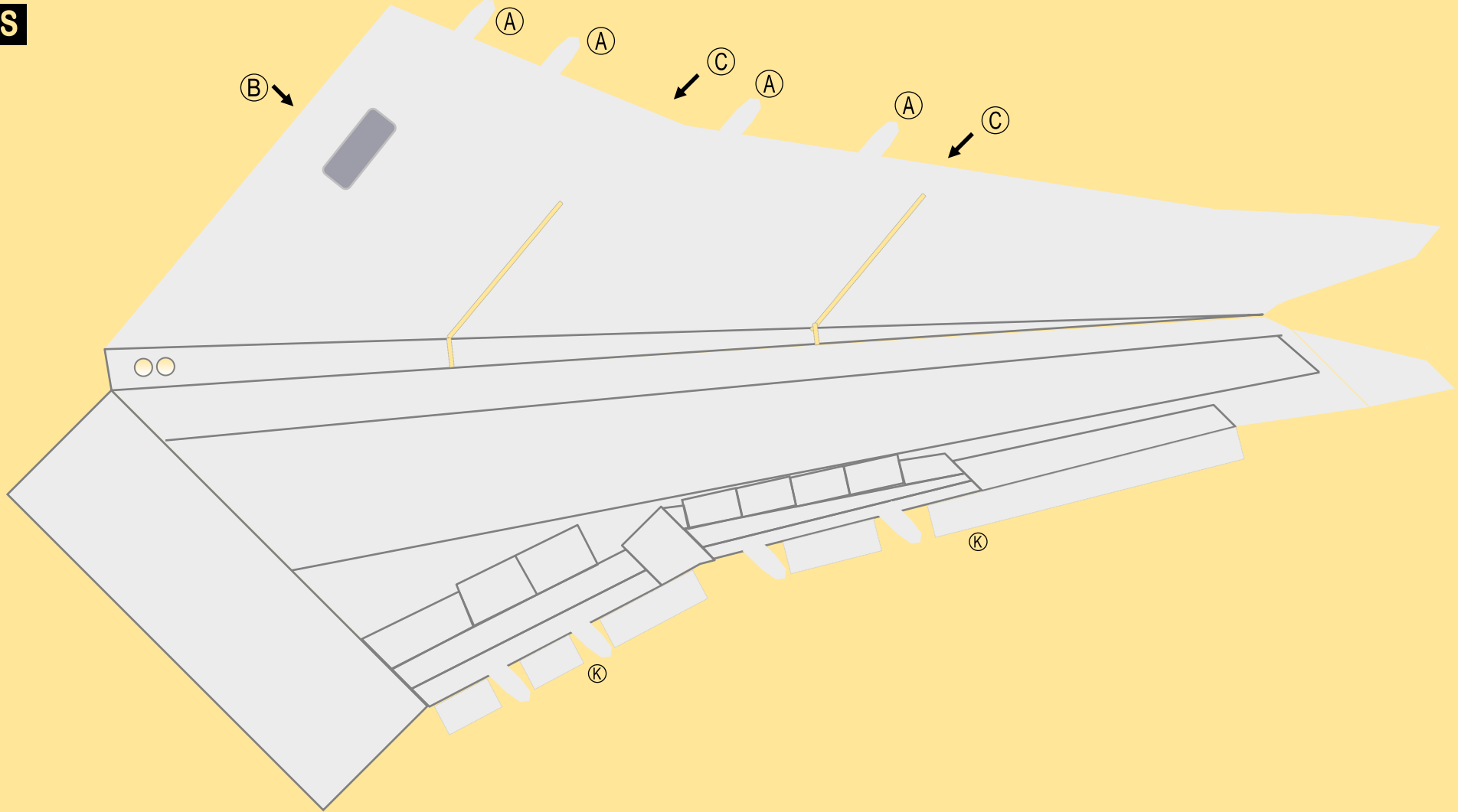

GS



WS

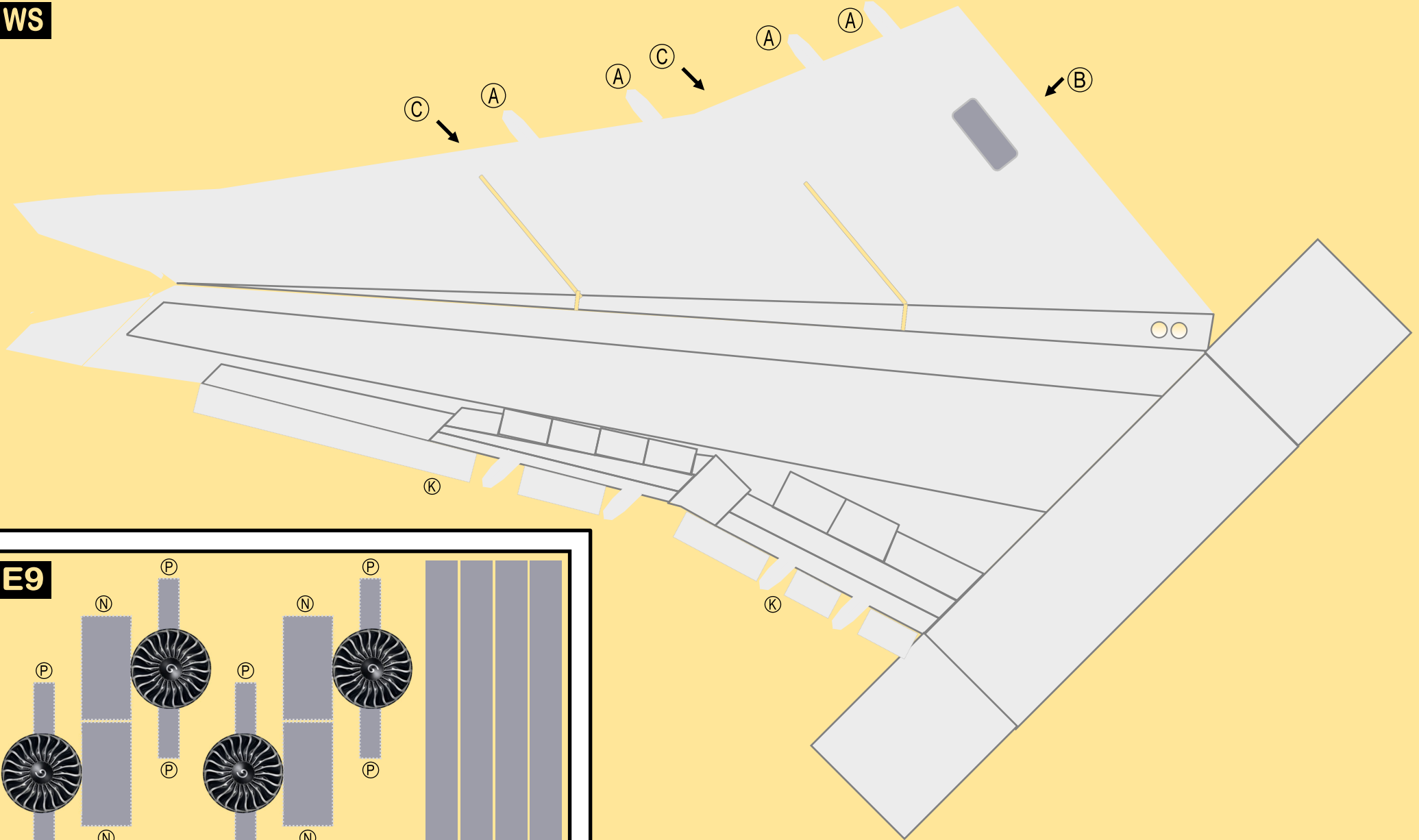

E9

