

Instructions for the following aircraft types:

AIRBUS	BOEING	BOMBARDIER	COMAC	EMBRAER
A318-100*	737-600	CS-100	C-919	EMB-170
A319-100*	737-700	CS-200		
A320-100*	737-800			
A320-200*	737-900			
A320-NEO	757-200			
A321-200*	757-300			
A321-NEO	767-200			
A330-200**	767-300			
A330-300**	767-400			
A330-NEO	777-200			
A350-900	777-300			
A350-1000	787-8			
	787-9			
	787-10			

* P&W Engines Only

** GE and P&W Engines Only

 **ACTIONS LEGEND****FOLD**

Make a sharp fold along the dotted lines of the object as indicated. Be careful to ensure that you are folding in the correct direction — some folds may be inverse. After folding, pass a ruler or other straight object over the fold to increase the crispness of the fold.

**CURVE**

Bend the object to create a cylindrical effect. Ensure that you are bending the object in the correct direction, as there are no guide lines provided for curved shapes. Important! Do not fold the object — folding the object will ruin the appearance of the object.

**CUT**

Cut along the lines as indicated. For most shapes, the cutting line is faintly represented so as not to spoil the appearance of the object with unnecessary lines — the cutting line will generally be the border between the object shape and the surrounding neutral colour.

**TAPE**

For some joins, it is preferable (though not required) to use tape. We recommend using Scotch tape suitable for archiving, to avoid discolouration. Use the tape sparingly, as too much tape may spoil the appearance of the object.

**GLUE**

For many joins, we recommend using glue. Apply the glue carefully to the “hidden” side of the join (i.e., generally the non-printed area). Press down the other part of the join on the glued section until bonded. We recommend using glue sticks, as liquid-based glue can spoil the paper of card by causing it to become soggy.

**SET ASIDE**

Once an object has been completed, it may be set aside until other objects have also been completed. Keep the completed object in a safe place until it is time to arrange it further.

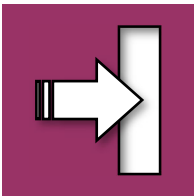
**INSERT**

Insert the object into the opening in the other corresponding object as shown. Once inserted, depending on the object, either join the objects together on the interior, or alternatively close and seal the larger object.

**VERSIONS**

Papier Avion, or 9G, represents an evolution of the Airigami design. Though some of these instructions may apply to earlier generation models from 2001-2005, there are some significant differences. Please note that we do not provide support or instructions for our earlier generation designs.

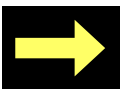

GETTING STARTED

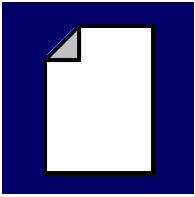

PRINTING

The first step in building a paper model is, of course, the putting the design to paper. Some things to bear in mind:

- Papier Avion / Airigami models are designed to fit A4 paper. Printing at 100% scale will produce models that are approximately 1:200 scale. However, you can use the scaling function in Adobe Acrobat to either increase or decrease the scale. For example, if you adjusted Adobe Acrobat print settings to 50%, you would print models at 1:400 scale; similarly, if you printed on A3 size paper and scale to 200%, you would print models at 1:100 scale.
- We strongly recommend that Papier Avion / Airigami models be printed on heavier stock. We recommend glossy 80lbs paper — if the paper is too light (like normal office paper) the models will tend to 'sag'; if the paper is too heavy, it may be too difficult to fold or manipulate in the building process. (Glossy paper also makes the models look nicer.)



KNOW-YOUR-PARTS

We try to make Papier Avion / Airigami instructions intuitive, using commonly used terms for each part.

WF *Wing Fairing (6 or 8 pieces)* **MG** *Main Landing Gear (2 pcs)* **EN** *Engines (8 pieces)*

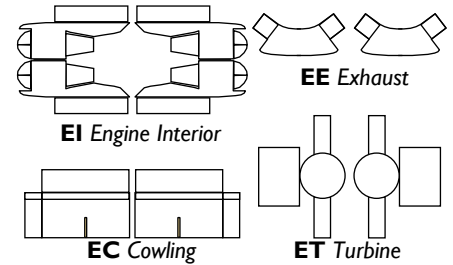
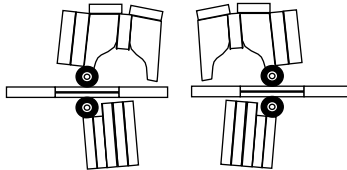
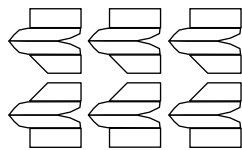

WG *Wings (1 or 2 pieces)**

NG *Nose Landing Gear (1 pc)*

TS *Tail Section (2 pieces)*

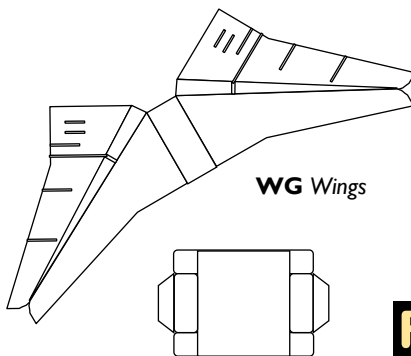

* For larger aircraft, the wings may be printed separately and require joining together

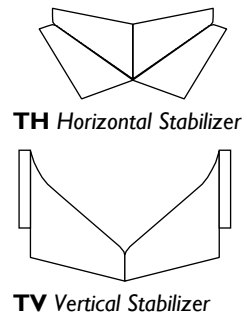
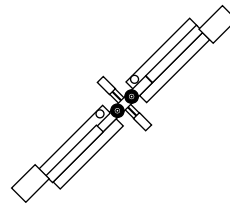

FU *Fuselage (1 or 2 pieces)**

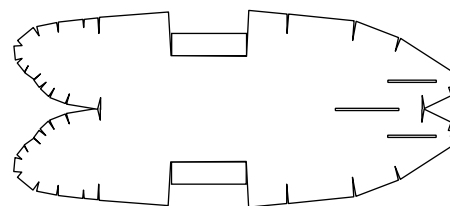

* For larger aircraft, the fuselage may be printed in two pieces and require joining together

ORDER OF CONSTRUCTION



WF WING FAIRINGS

STEP
1

1

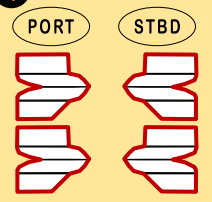

Cut out the objects in Section WF.



STEP
2

1

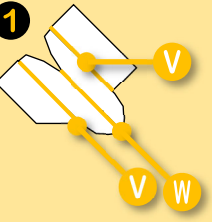

Fold each of the *Wing Fairings*. For each *Wing Fairing* object, fold down along the middle line first (**W**).



2

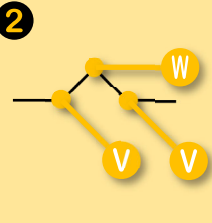

Then, make inverse folds up along the two parallel fold lines (**V**).



STEP
3

1

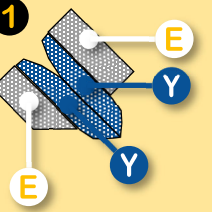

Apply glue to the non-printed side of the *Wing Fairings*. Apply glue only to the (**Y**) zones demonstrated above. Do not glue outside these zones.



2

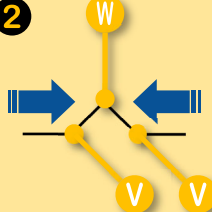

On the printed side, apply pressure to the two sides of the object to ensure the glue adheres.



3

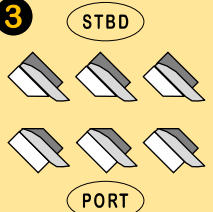

Once completed, set the objects aside until they are needed at a later stage.



MG MAIN LANDING GEAR

STEP 1

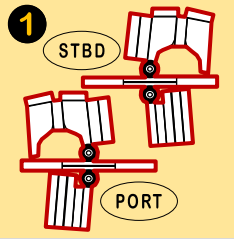

Cut out the objects in Section MG.

STEP 2

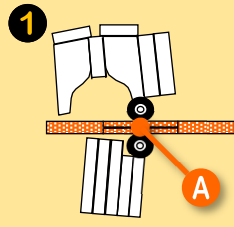

For each *Main Landing Gear*, curve the (A) section.

2

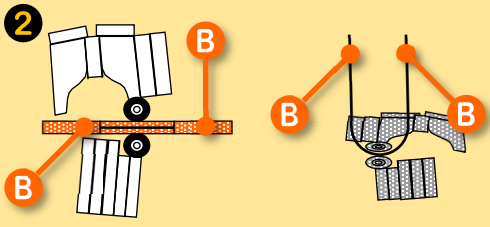

Curve section (A) so the two (B) strands are parallel, back-to-back.

STEP 3

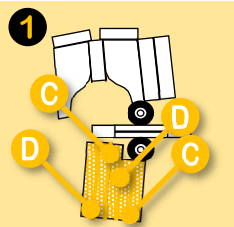

Fold the smaller highlighted component of the *Main Landing Gear* piece. Fold along the (C) lines.

2

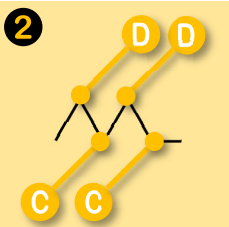

Then, make inverse folds along (D) lines. The section should then resemble a concertina or accordion fold.

STEP 4

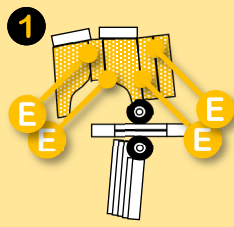

Fold and assemble the larger highlighted component of the *Main Landing Gear* piece. Fold along the (E) lines to create what will become a 'box'-like structure.

2

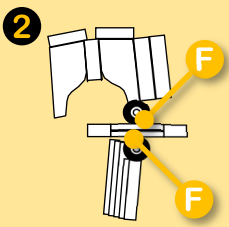

Fold along the (F) lines such that the two large sides will sit roughly back-to-back.

3

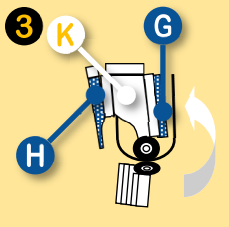

Apply glue to the face of the highlighted (G) area. Swing the (J) section inside the 'box' structure of section (K).

4

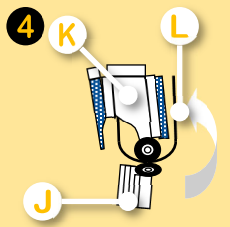

Tuck the two middle (L) strands within the 'box' of section (K). Close the 'box' of section (K) by adhering section (H) on top of area (G).

5

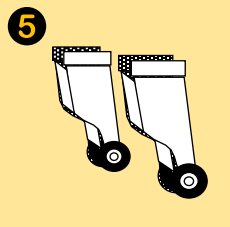

Once completed, set the objects aside until they are needed at a later stage.

EN ENGINES

STEP 1

1

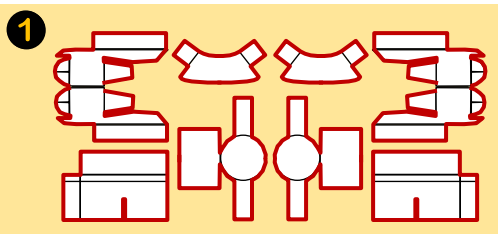

Cut out the objects in **Section EC, Section EN, Section ET, and Section EX.**



STEP 2

1

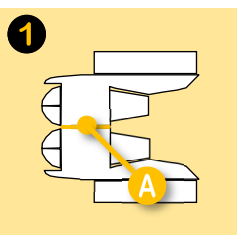

For each *Engine Interior* object, make folds along the **(A)** line.



2

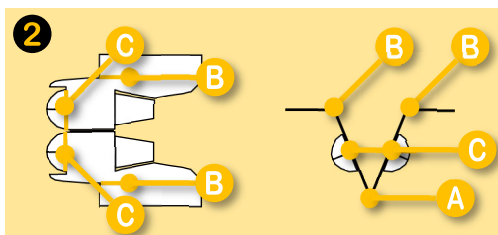

Then, make inverse folds along the **(B)** and **(C)** lines.



3

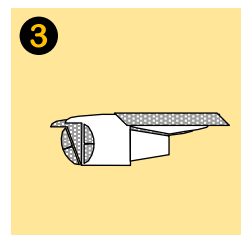

Once completed, set the objects aside until they are needed later.



STEP 3

1

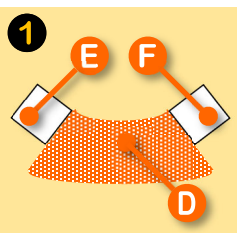

For each *Exhaust* object, curve highlighted **(D)** section so that the **(E)** and **(F)** tabs touch back-to-back.



2

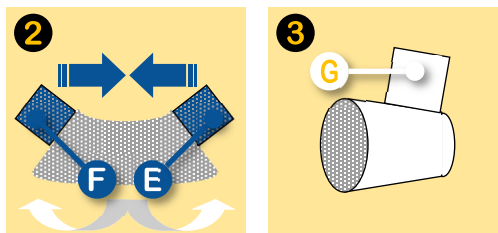

Apply glue to the non-printed side of the **(E)** and **(F)** tabs, and press them together to adhere.



3

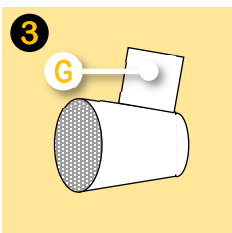

The **(E)** and **(F)** tabs joined together become one single tab **(G)**. Set the objects aside until they are needed later.



STEP 4

1

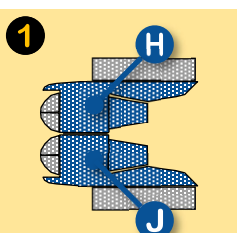

Assemble *Engine Interior* from Step 2 and *Exhaust* from Step 3. Apply glue to the non-printed side of the *Engine Interior* **(H)** and **(J)** section. Do not adhere the two sides yet.



2

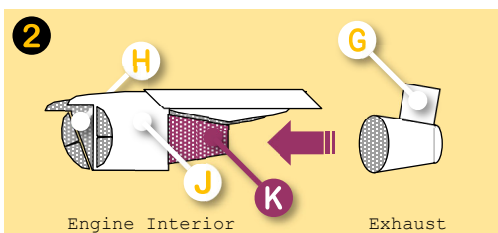

Slot the *Exhaust* section into the *Engine Interior* section such that the *Exhaust* section covers the highlighted section **(K)** and the **(G)** tab is 'sandwiched' between sections **(H)** and **(J)**.

Engine Interior Exhaust



3

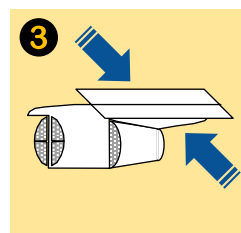

Then, quickly press and adhere the **(H)** and **(J)** sections together, so they create a 'sandwich' with the **(G)** tab in the middle.



4

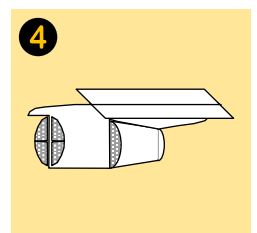

Once completed, set the objects aside until they are needed later.



EN ENGINES

STEP
5

1

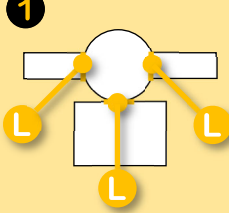

Assemble the *Turbine* section. Fold along the (L) lines.



2

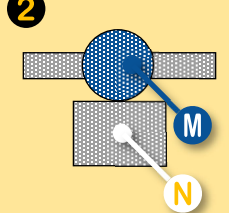

Apply glue to (M) area on the non-printed side of the *Turbine* section.



3

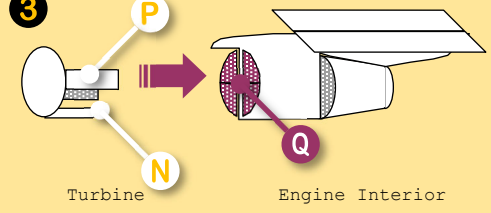

Turbine Engine Interior

Press the *Turbine* section onto the highlighted area (Q) of the *Engine Interior* section and adhere. Ensure that the (N) area of the *Turbine* section is positioned at the bottom of the *Engine Interior* section.



4

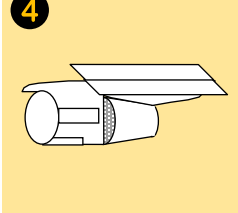

Once completed, set the objects aside until they are needed at a later stage.



STEP
6

1

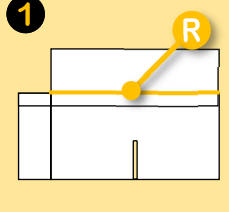

Assemble the *Cowling* section. Fold along the (R) line.



2

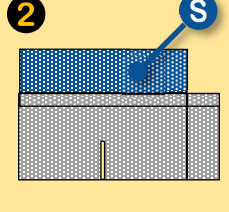

Apply glue to the non-printed side of the (S) section and press back-to-back against the rest of the *Cowling* section.



3

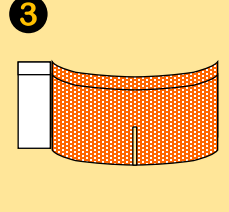

Curve the *Cowling* section.



4

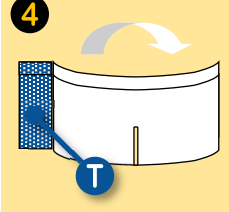

Apply glue to the printed (T) area. Curve the *Cowling* and press the (T) tab under the rest of the *Cowling* section and adhere.



5

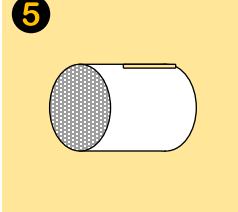

Once completed, set the objects aside until they are needed at a later stage.



STEP
7

1

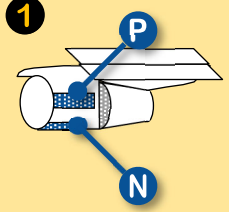

Assemble the *Engine Interior* from Step 5 and *Cowling* section from Step 6. Apply glue to the (N) and (P) tabs of the *Engine Interior*



2

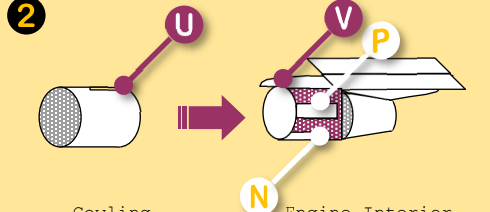

Cowling Engine Interior

Slide the *Cowling* section over the front of the *Engine Interior* section. Slot the (V) section into/over the (U) slot in the *Cowling*. *Cowling* section will cover the highlighted area of *Engine Interior* section. Note! The *Cowling* section does not completely slide over the *Engine Interior* — the (S) area remains forward of the *Turbine*.



3

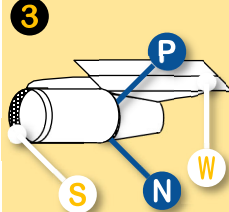

Then, quickly press and adhere the (N) and (P) tabs against the interior of the *Cowling* section to adhere them together.



4

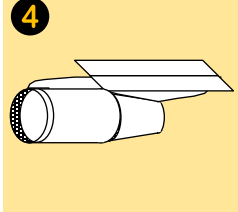

Once completed, set the objects aside until they are needed at a later stage.



WG WINGS

STEP

1

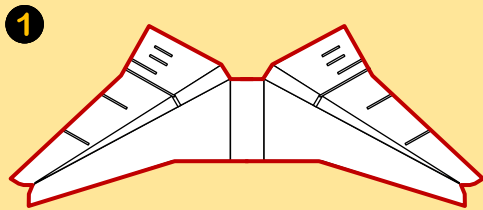

Cut out the objects in Section **WG** — either object **WG1** or both objects **WG2** and **WG3**.

STEP

2

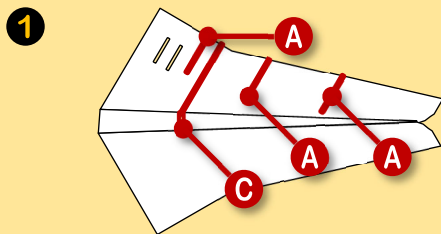

Cut out the slots for the engines, wing fairings, and engines. Note that the precise placement and number of the slots will vary by aircraft type. For **(A)** and **(C)** slots, simply cut inwards from

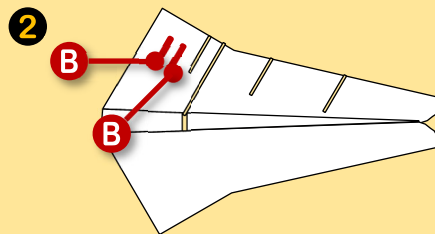

For **(B)** slots, either use a razor or cut from the inside, remove the yellow sections, and then repair the cut wing sections with tape on the interior.

STEP

3

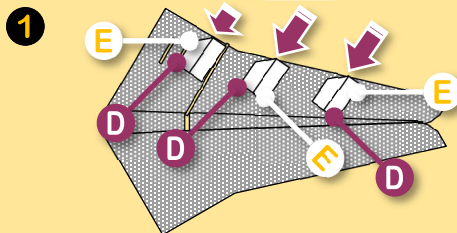

Insert the completed *Wing Fairings* (**WF0** through **WF9**) into the appropriate slots. Insert port-side *Wing Fairings* (**E**) into the port-side wing into the **(D)** slots.

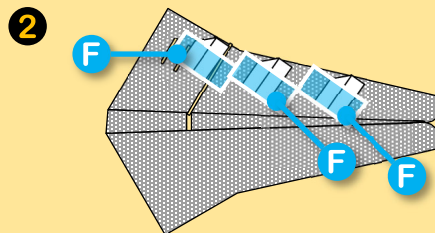

Apply small pieces of tape (**F**) over the interior flaps of the *Wing Fairings* (on the interior of the wing). Repeat the same steps for the starboard-side wing.

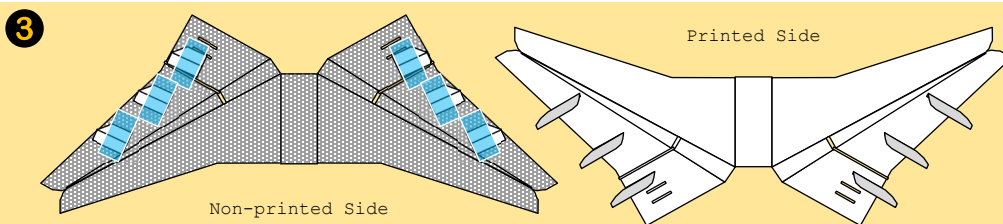



Once completed, set the objects aside until they are needed at a later stage.

WG WINGS

STEP

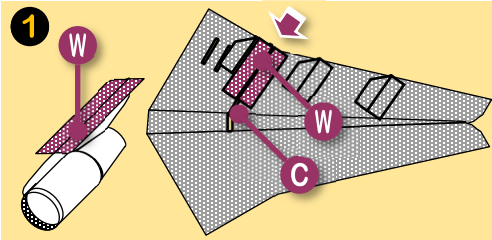
4



1 Insert completed *Engines* into the appropriate slots depending on port or starboard. Note that the precise placement and number of the slots will vary by aircraft type. Insert port-side *Engine* (**W**) tabs into the port-side wing into the (**C**) slot. 

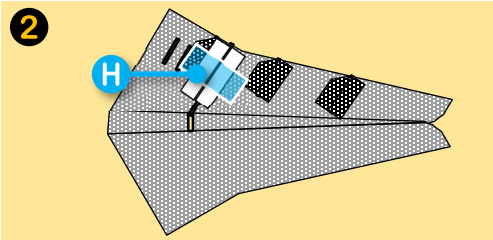

2 Apply a small piece of tape (**H**) over the interior tabs of the *Engine* (on the interior of the wing). Repeat the same steps for the starboard-side wing. 

STEP

5

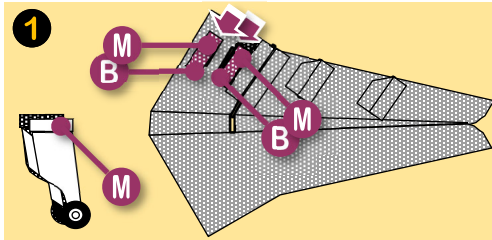

1 Insert the completed *Main Landing Gear* into the appropriate slots. Insert port-side *Main Landing Gear* (**M**) tabs into the port-side wing into the (**B**) slots. Fold the (**M**) tabs downward in opposing directions. 

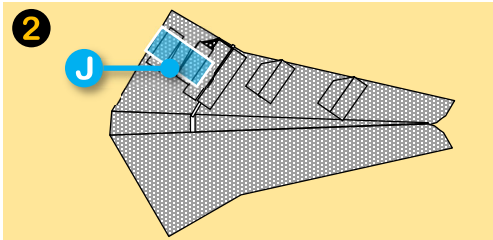

2 Apply small pieces of tape (**J**) over the interior tabs of the *Main Landing Gear* (on the interior of the wing). Repeat the same steps for the starboard-side wing. 

STEP

6

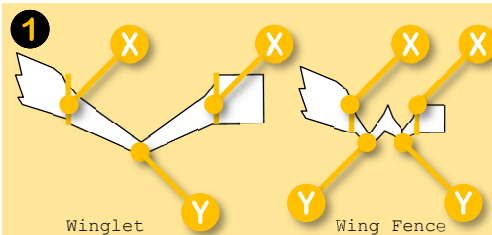

If there are *Winglets* or *Wing Fences*, assemble as follows: For each *Winglet* or *Wing Fence* object, fold down along the (**Y**) lines. Then, make inverse folds up along the (**X**) lines. 

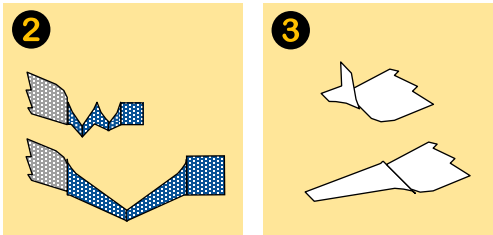

2 Apply glue to the non-printed side of the *Winglet* or *Wingfence*. 

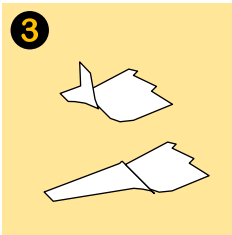

3 Fold over along the (**Y**) lines so that the neighboring sections are back-to-back. Press together to adhere. 

WG WINGS

STEP

7

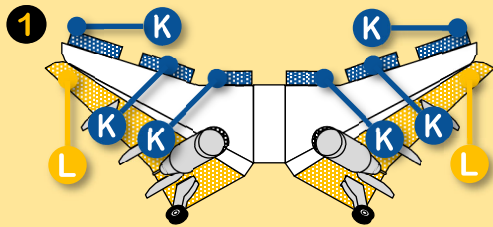

Apply glue to the printed side of the **(K)** tabs and fold them so that they are back-to-back with the rest of the *Wing*. Fold over the **(L)** sections of each wing such that they sit on top of the **(K)** tabs. Press together to adhere.



2

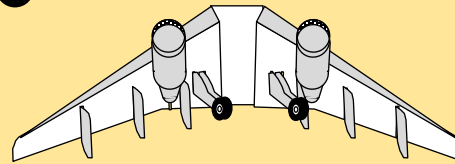

Underside

Once completed, set the objects aside until they are needed at a later stage.



STEP

8

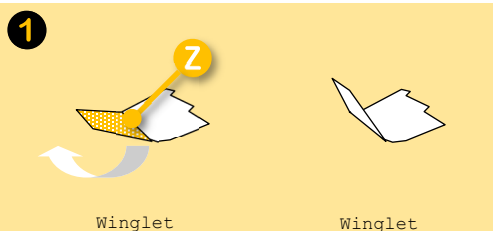

Winglet

Winglet

If there are *Winglets*, assemble as follows: For each *Winglet*, fold along the **(Z)** line, such that the winglet is upright at a 45-degree angle outwards from the wing.



2

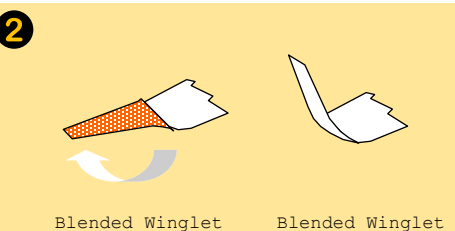

Blended Winglet

Blended Winglet

If there are *Blended Winglets*, assemble as follows: For each *Blended Winglet*, curve Winglet upwards such that the winglet is upright at a 45-degree angle outwards from the wing.



STEP

9

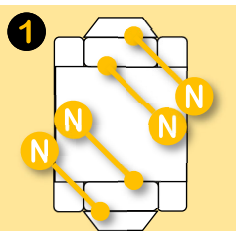

Assemble the *Wing Box* section. Fold along the **(N)** lines.

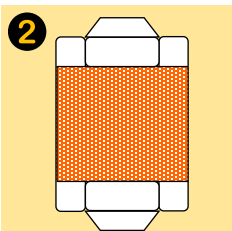

Curve the highlighted area (rather than folding it).



3

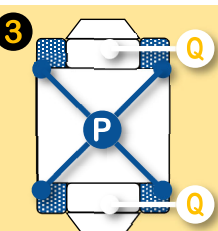

Apply glue to **(P)** tabs.

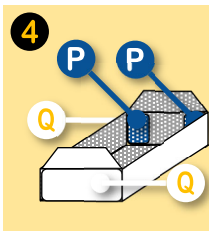

Press the **(P)** tabs onto the back-side of the corresponding **(Q)** sections and adhere.



STEP

10

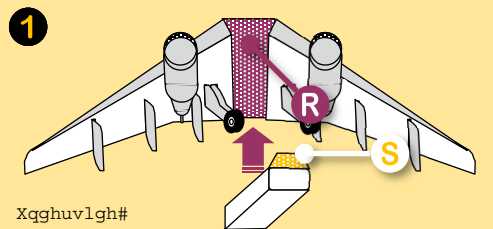

Xqghuvlgh#

Place the *Wing Box* over the highlighted **(R)** area on the underside of the *Wing* section, between the port and starboard wings.



2

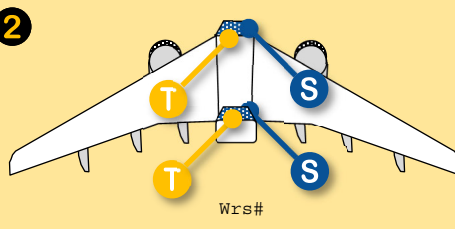

Wrs##

Apply glue to the non-printed side of the **(S)** tabs. Fold along the **(T)** lines.



3

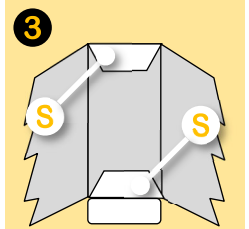

Press the **(S)** tabs down onto the top of the *Wings* section to adhere.



TS TAIL SECTION

STEP 1

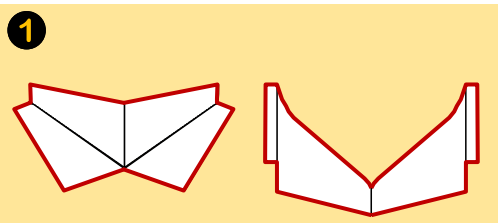

1

Cut out the objects in **Section TH** and **Section TV**.

STEP 2

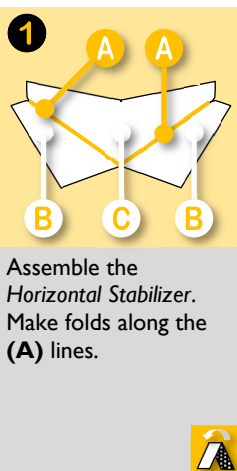

1

Assemble the *Horizontal Stabilizer*. Make folds along the **(A)** lines.

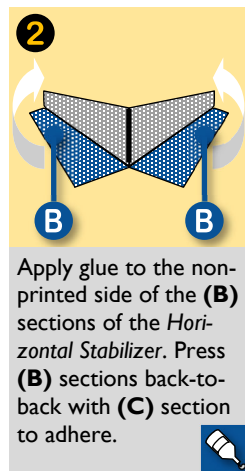

2

Apply glue to the non-printed side of the **(B)** sections of the *Horizontal Stabilizer*. Press **(B)** sections back-to-back with **(C)** section to adhere.

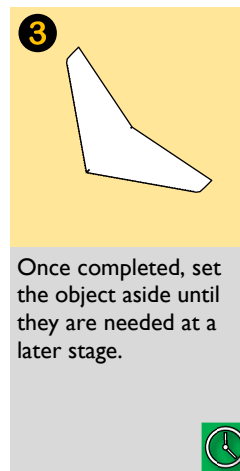

3

Once completed, set the object aside until they are needed at a later stage.

STEP 3

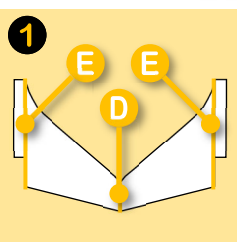

1

Assemble the *Tail*. Make folds along the **(D)** line. Then, make inverse folds along the **(E)** lines.

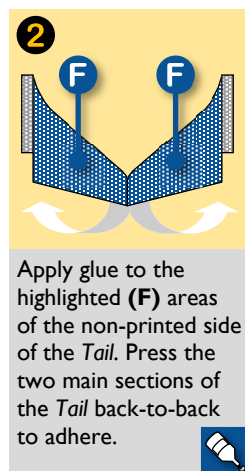

2

Apply glue to the highlighted **(F)** areas of the non-printed side of the *Tail*. Press the two main sections of the *Tail* back-to-back to adhere.

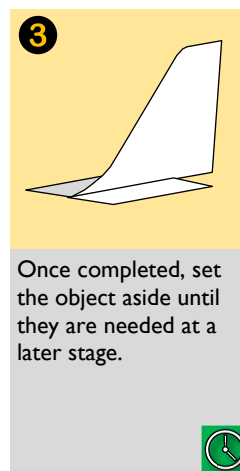

3

Once completed, set the object aside until they are needed at a later stage.

NG NOSE LANDING GEAR

STEP
1

1

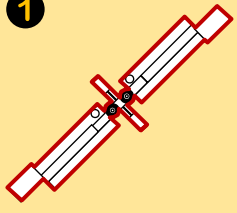

Cut out the objects in Section NG.



STEP
2

1

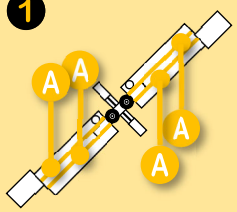

Fold the Nose Landing Gear. Fold along the (A) lines.



2

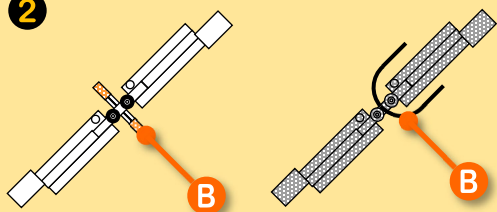

Curve the (B) section so that the two (B) strands are parallel.



STEP
3

1

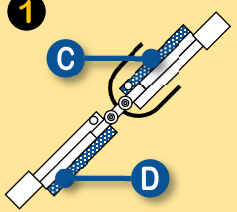

Apply glue to the face of the highlighted (C) and (D) areas.



2

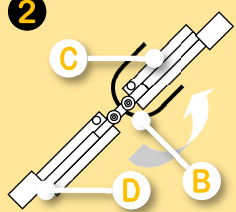

Swing section (C) inside the 'box' structure of section (D). Tuck the two middle (B) strands within the 'box' of section (D).



3

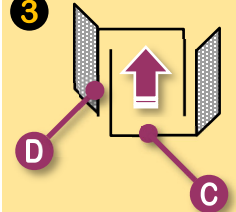

Close the 'box' of section (D) by adhering section (D) on top of area (C).



4

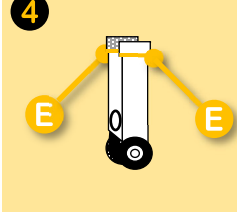

Fold the along the (E) lines to push the (F) tabs down so that they are at a 90 degree angle to the structure.



5

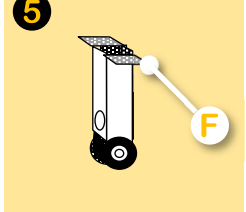

Once completed, set the objects aside until they are needed at a later stage.



FU FUSELAGE

STEP

1

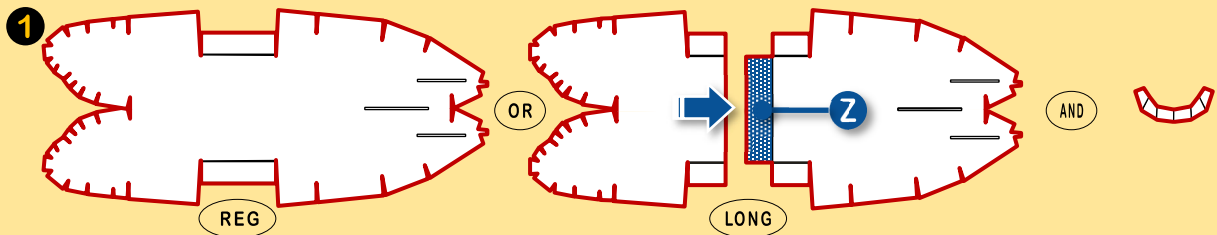

Cut out objects in **Sections FU** and **CK** — either object **FU** *or* both objects **FU1** and **FU2**. For Long fuselage aircraft (where the *Fuselage* piece is split between two parts), apply glue to highlighted (**Z**) area. Place the rear edge of the front *Fuselage* section above (**Z**) tab and press down to adhere.



STEP

2

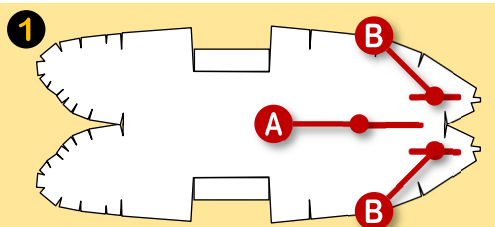

Cut out the slots for the *Horizontal Stabilizers* and *Tail*. For (**A**) and (**B**) slots, either use a razor or cut from the inside, remove the yellow sections, and then repair the cut wing sections with tape on the interior.



STEP

3

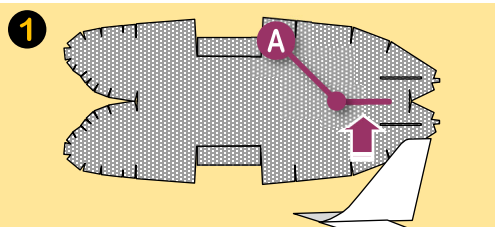

Insert the completed *Tail* into the fuselage. Insert the *Tail* section through slot (**A**), pushing the top of the tail through the slot from the non-printed side upwards.

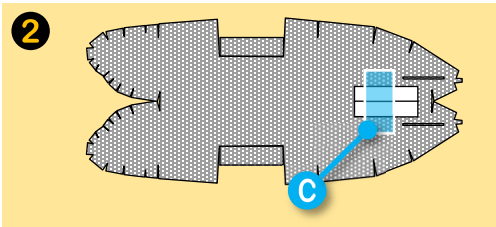

Apply a small piece of tape (**C**) over the interior flaps of the *Tail* (on the interior of the fuselage).

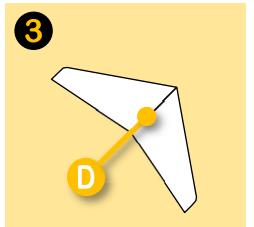

Make a slight fold along the (**D**) line of the *Horizontal Stabilizer*.

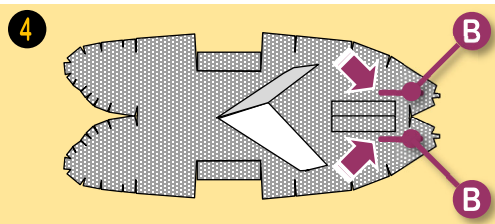

Insert the completed *Horizontal Stabilizers* into the fuselage. Insert the ends of the *Horizontal Stabilizer* section through the (**B**) slots, pushing the ends through the slots from the non-printed side upwards.

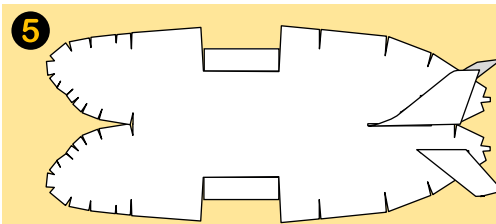

Ensure that the *Horizontal Stabilizer* is roughly centered between the two (**B**) slots.

FU FUSELAGE

STEP

4

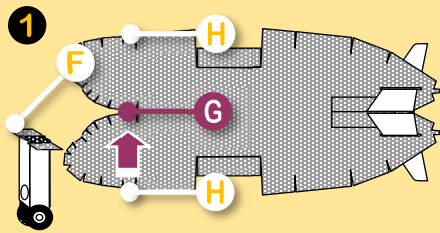

Attach the Nose Landing Gear to the fuselage. Identify the point that is precisely the middle point on the non-printed side of the fuselage between the two (H) tabs. Note that this point is not printed, however a line may be ruled between the two points with a pencil to help identify it.

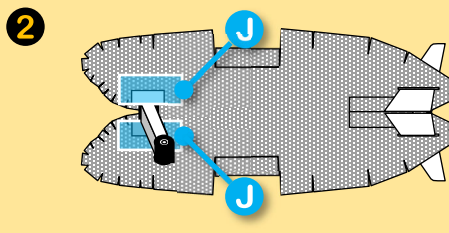

Place the Nose Landing Gear (F) tabs on the middle point identified in above. Apply small pieces of tape (J) over the (F) tabs of the Nose Landing Gear to adhere to the interior of the fuselage.



STEP

5

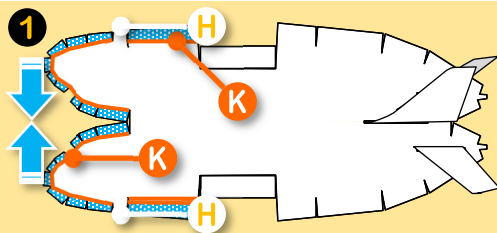

Curve the tabs highlighted at the front of the Fuselage section along the (K) lines. Do not make folds of these tabs, otherwise the aircraft will appear 'boxy'. Place small pieces of tape on the inside or outside of the highlighted tabs, and pull the corresponding tabs together and adhere. Do not adhere the (H) tabs.

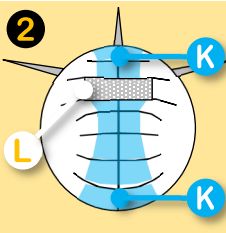

Line up each corresponding tab and adhere. Though more challenging to place the tape inside, it gives a 'cleaner' appearance.

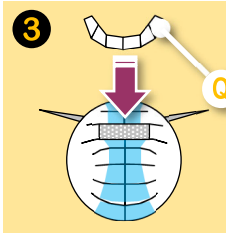

Place the Cockpit Windows over (or under) the gap between the (L) points on the Fuselage.

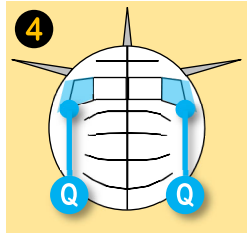

Place small pieces of tape (either on the outside or underside) to adhere the (Q) points of the Cockpit Windows to the Fuselage.

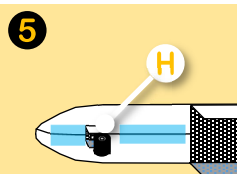

Pull the Nose Landing Gear through the gap of the (H) tabs.

FU FUSELAGE

STEP
6

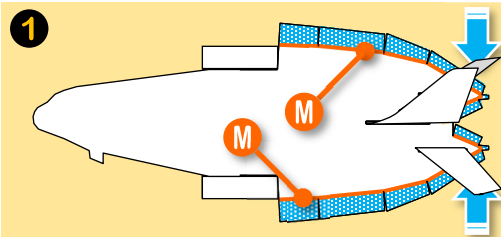

Curve the tabs highlighted at the rear of the *Fuselage* section along the (M) lines. Do not fold these tabs, otherwise the aircraft will appear 'boxy'. Place small pieces of tape (L) on the inside or outside of the highlighted tabs, and adhere the corresponding tabs together.

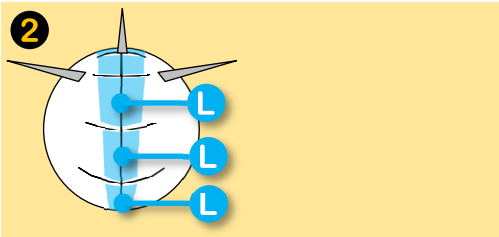

Line up and adhere each corresponding tab. Though more challenging to place the tape inside, it gives a 'cleaner' appearance.

STEP
7

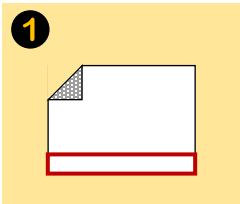

From the scraps of paper left over, cut a strip the length of the sheet, about an inch wide.

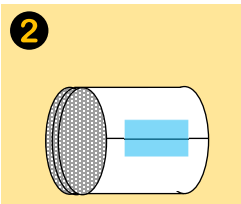

Roll the scrap of paper up into a tight cylinder. Apply a small piece of tape to close the cylinder. This forms the "Ballast".

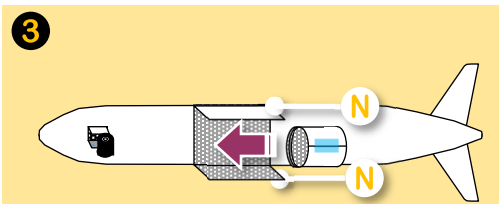

Place the *Ballast* into the *Fuselage* section, forward of the *Wings* section. The purpose of the *Ballast* is to balance aircraft that are otherwise tail-heavy.



STEP
8

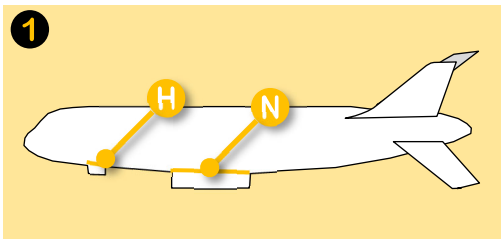

Fold along (N) lines on both sides of the *Fuselage* so the corresponding tabs meet. Make inverse folds along (H) lines on both side of the *Fuselage* such that the two tabs stand

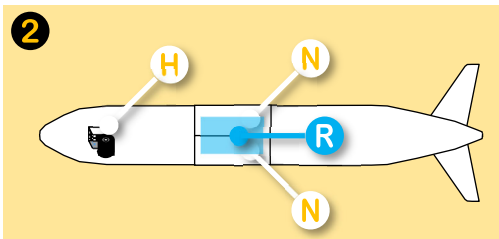

Place a small piece of tape across the two (R) tabs to adhere.



STEP
9

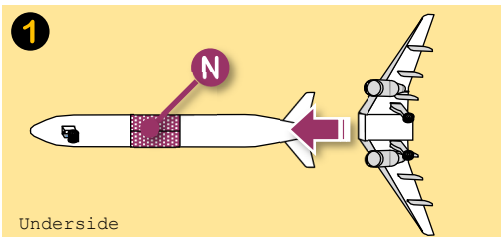

Insert the *Wing* section under the (N) tabs of the *Fuselage* section. Note that the *Wing* section does not need to be adhered — it can be inserted and removed as needed to allow for more efficient storage.

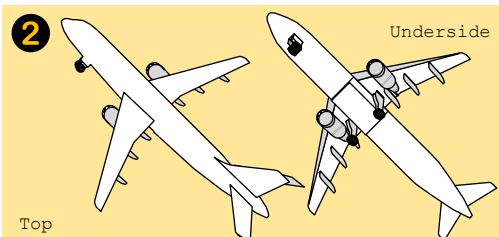

... and your model is complete! Enjoy.



www.papieravion.org